

Male J.I.C. (37°) x Female O-Ring (O.R.B.)

Not Available
In Stainless Steel!

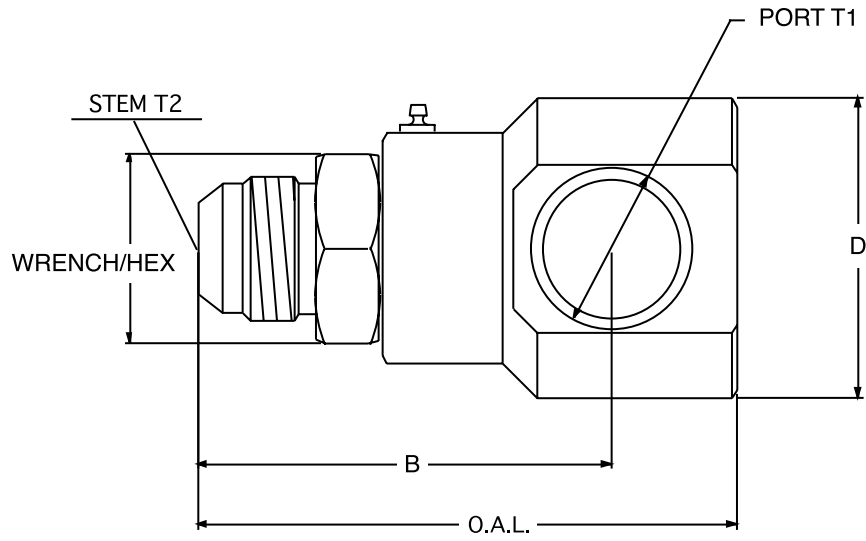

PART NUMBER	O.A.L.	DIM. B	DIM. D Ø	WRENCH/HEX	PORT T1	STEM T2	SWG. RADIUS	MAX. P.S.I.G.	THROUGH HOLE
9 SS 4 MJ 4 X FO 6	2.837	2.325	1.292	0.750	9/16-18 U.N.	7/16-20 U.N.	0.541	5000	0.172
9 SS 4 MJ 6 X FO 6	2.857	2.345	1.292	0.750	9/16-18 U.N.	9/16-18 U.N.	0.541	5000	0.250
9 SS 8 MJ 8 X FO 8	3.238	2.644	1.662	1.000	3/4-16 U.N.	3/4-16 U.N.	0.703	5000	0.391
9 SS 8 MJ 10 X FO 8	3.338	2.744	1.662	1.000	3/4-16 U.N.	7/8-14 U.N.	0.703	5000	0.484
9 SS 12 MJ 12 X FO 12	3.845	3.020	2.172	1.375	1 1/16-12 U.N.	1 1/16-12 U.N.	0.900	4500	0.609
9 SS 16 MJ 16 X FO 16	4.695	3.780	2.482	1.625	1 5/16-12 U.N.	1 5/16-12 U.N.	1.009	4000	0.827
9 SS 20 MJ 20 X FO 20	5.207	4.124	2.977	1.750	1 5/8-12 U.N.	1 5/8-12 U.N.	1.184	4000	1.078